



ORTHOPAEDIC INSTRUMENTS



THE WORLD CLASS QUALITY ORTHOPEDIC INSTRUMENTS

Vaishanav Surgial Co.

Following the 21st century vision of becoming a true global leader who can make its Customers worldwide through its quality products and services. We are dedicated to manufacturing and marketing instruments which provide practical Solutions to real life problems, And meet the needs of our customers. We insist on high quality, efficient manufacturing Teamwork, and integrity, growing from our deep respect and honour for god, our Employees, our vendors, our customers and all our other stakeholders.

We stand behind every product we offer. Each of us, from the production department To the sales department makes customer satisfaction a top priority.

The careful management of people and projects ensures we continue to enjoy our Reputation for providing excellent quality services to our customers. The most important part of our philosophy is to work in partnership with clients and This requires, in our view, direct contact between our clients and us from the word go.

We aim:

- >> To listen to our customers and exceed their expectations, ensuring they are completely Satisfied with our products, services and support so that they will continue working with us.
- >> To continue expanding our research programs in progressive technologies.
- >> To secure international recognition by adopting a global rather than local perspective And by achieving excellence in the quality of our instruments.
- >> To continue building our excellent team of top professionals through controlled expansion,

ELEVATORS

Adson Periosteal Elevator	1
Pennybacker Periosteal Elevator	1
Bone Raspatory with Tufnol Handle	1
Farabeuf Rugine Elevator	1
Trethowan Bone Elevator	2
Lanes Bone Elevator	2
Fagge Bone Elevator	2
Bristow Periosteal Elevator	2
Femoral Dislocation Lever	2
Muller Femoral Retractor	2
Mini Bone Lever	3
Hohmann Style Mini-Bone Lever	3
Phalangeal Lever	3
Buck-Gramcko Lever	3
Mini-Cobra Bone Lever	3
McGlamry Metatarsal Elevator	3
Hohmann Bone Elevators	4 & 5
Modied Cobra Aufrang Elevator	5
Shallow Bone Elevator	5
Concave Moor Elevator	5
Murphy Bone Skid Elevator	6
Infero-Posterior Acetabular Retractors	6
PCL Retractor	6
Wide Prong PCL Retractor	6

BONE HOOKS

Bone Hook Sharp	7
Blunt Hook	7
Wroblenski Dislocating Hook	7
McMinn Dislocating Hook	7

BONE SPREADERS

Scaphoid Spreaders	8
Baby Inge Bone Spreader	8
Scaglietti Lamina Spreader	8

BONE CUTTERS

Bohler Bone Cutters	9
McIndoe Bone Cutters	9
Ruskin-Liston Bone Cutters	9
Stille-Liston Bone Cutters	9
Liston-Key-Horsley Bone Cutters	9

BONE NIBBLERS

Kleinert-Kutz Bone Nibbler	10
Lempert Bone Nibbler	10
Luer Bone Nibbler	10
Adsons Bone Nibbler	10
Bohler Bone Nibbler	11
Marquardt Bone Nibbler	11
Beyer Bone Nibbler	11
Jansen Bone Nibbler	11
Smith-Peterson Bone Nibbler	12
Leksell Bone Nibbler	12
Stille-Luer Bone Nibbler	12
'Mr Blobby' Stille-Luer Bone Nibbler	12

BONE HOLDING FORCEPS

Langenbeck Bone Holding Forceps	13
Frosch Bone Holding Forceps	13
St. Thomas Bone Holding Forceps	13
Fergusson Bone Holding Forceps	13
Langenbeck Bone Holding Forceps	13
Semb Bone Holding Forceps	14
Hey Groves Bone Holding Forceps	14
Verbrugge Bone Holding Forceps	14

PELVIC REDUCTION INSTRUMENTS

Pelvic Reduction Forceps	15 & 16
--------------------------	---------

RETRACTORS

Meyerding Retractor	17
Langenbeck Retractor	17
Volkman Catspaw	17
Charnley Initial Incision Retractor Set	18
West's S/R Retractor	19
Weitlaner S/R Retractor	19
Travers S/R Retractor	19
Norfolk and Norwich S/R Retractor	19
Gelpi Laminectomy Retractor	19
Charnley Vertical Retractor	20
Cones Self Retaining Retractor	20
Harvey Jackson Self Retaining Retractor	20
Charnley Horizontal Hip Retractor	21
Hadinge Horizontal Retractor	21
Charnley Pin Retractor	21
Viper Scoliosis Retractors	22

MALLETS

Toe Mallet	23
Ultra Fine Mallet	23
Heath Mallet	23
Mallet with Tufnol Handle	23
London Splint Mallet	24
Ombredanne Mallet	24
Mallet with Tufnol Handle-lead lled head	24
Tufnol Mallet	24

OSTEOTOMES

Mini-Lambotte Osteotome	25
Lambotte Osteotome	25
Ultra Fine Osteotome	25
Mini-Stille Osteotome	26
Stille (Swedish) Osteotome	26
Hibbs Osteotome with thin blade	26
Smith Petersen Osteotome	26
Mini-Lexer Osteotome	27
Lexer Osteotome	27
Dahmen Osteotome	27
Box Chisel	28
Pelvic Osteotome	28
Chisel with 4 Interchangeable Blades	28
Capener Lamina Gouge	28

BONE CURETTES

Volkman Curette	29
Muller Curette with Tufnol Handle	29
Charnley Bone Curette	29
Charnley Ring Curette	29

HIP RIVISION INSTRUMENTS

Cup Extraction Chisel	30
Bayonet Gouge	30
Swan Necked Gouge	30
Cement Gouge	30
Cement Chisel Angled 15°	30
Cement Osteotome	31
Cement Splitting Osteotome	31
Straight Cement Gouge	31
Bayonet Cement Rasp	31
Bayonet Cement Chisel	32
Bayonet Cement Splitting Osteotome	32
Bayonet Cement Gouge	32
Malleable Cement Probe	33
Cement Plug Extractor	33
Retrograde Cement Chisel	33
Slotted Mallet	33
Cement Extraction Hook	33
Cement Twist Drill	34
Fine Cement Duckbill Grasping Forceps	34
Heavy Cement Grasping Forceps	34
Femoral Head Extractor	35
Moore Femoral Head Extractor	35
Joint Capsule Clamp	35
Joint Capsule Scissors	35

HIP JOINT INSTRUMENTS

Femoral Head Impactor	36
McGoey Bone Punch	36
Hardinge Cement Restrictor	36
Femoral Pusher	36

PLIERS & WIRE CUTTERS

Universal Fine Pliers & Cutters	37
Slim & Square Ended Wire Pliers	37
Pliers for Screw Removal	37
Muller Claus Wire Pullers	37
Muller Claus Wire Cutters	38
End Wire Cutters	38
Bolt Cutters with dismantable arms	38
Combined Wire Cutters & Pliers	39
Wire Cutters with T/C Jaws	39
'Power Cut' Wire Cutters	39

LOCKING PLIERS

Needle Nosed Locking Pliers	40
Orthopaedic Locking Pliers	40

PIN INTRODUCERS

Kirschner Wire Introducing T-Handle	41
Steinmann Pin Introducer T-Handle	41

MISC

Bone Mill	42
Wire Passing Guide	42
Bone Awl	42

SCREWDRIVERS

Slotted Head Screwdriver	43
Long Slotted Head Screwdriver	43
Phillips Head Screwdriver	43
Cross Slotted Head Screwdriver	43
Hexagonal Head Screwdriver	44

DISSECTORS

Howarth Elevator	45
MacDonald Elevator/Dissector	45
Watson Cheyne Dissector	45
Freers Elevator/Dissector	45
Swedish Dissector	45

MEASURING INSTRUMENTS

Stainless Steel Measuring Ruler	46
Measuring Caliper	46
Vernier Caliper	46
Depth Gauge	46

ARTHROSCOPY PUNCHES

Slimline Basket Punch	47
Regular Basket Punch	47
Duckbill Basket Punch	48
Duckling Basket Punch	48
Scissor Punch	49
Biopsy Rongeur	49
Hook Scissors	50
Oval Punch	50
Back Biter Punches	51
Scoop Basket Punch	51
Grasping Forceps	52

ARTHROSCOPES

Stryker Compatible	53
Dyonics Compatible	54
Regular Fitting	55

FIBRE OPTIC LIGHT LEAD

Fibre Optic Light Lead	56
Adaptors for Light Lead	56

DRILLS & K-WIRES

Twist Drills	57
Kirschner Wires	58

OPERATING CHAIRS

The Severn Surgeons Operating Stool	59
The Avon Surgeons Operating Stool	59
Coburg Micro Surgery Stool	60

Adson Periosteal Elevator

16cm/6¼" length
Curved blunt



	Width
SF-05-50001	5mm
SF-05-50002	7mm

Pennybacker Periosteal Elevator

16cm/6¼" length
Curved sharp



	Width
SF-05-50003	4mm
SF-05-50004	6mm
SF-05-50005	8mm

Bone Raspatory with Tufnol Handle

19cm/7½" length



Straight		Width	Curved		Width
SF-05-50006		6mm	SF-05-50007		3mm
			SF-05-50008		6mm

Farabeuf Rugine Elevator

15cm/6" length



Straight		Width
SF-05-50009		12mm
Curved		Width
SF-05-50010		12mm

illustrated

Farabeuf Rugine Elevator with Hollow Handle

16cm/6¼" length

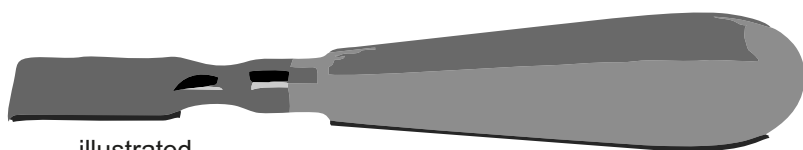

Straight		Width
SF-05-50011		12mm
Curved		Width
SF-05-50012		12mm

illustrated

Trethowan Bone Elevator

- 22.5cm/8½" length

SF-05-50013



Lanes Bone Elevator

- 26cm/10" length

SF-05-50014



Fagge Bone Elevator

- 27.5cm/10¾" length

SF-05-50015



Bristow Periosteal Elevator

- 23cm/9" length
- Curved sharp
- 10mm width

SF-05-50016



Femoral Dislocation Lever

- 31cm/12½" length
- 26mm width

SF-05-50017



Muller Femoral Retractor

- 35cm/13½" length
- 28mm width

SF-05-50018



For retraction of the femoral neck.

Mini Bone Lever

14cm/5½"
2.8mm width

SF-05-50019



Hohmann Style Mini-Bone Lever

16cm/6¼"
6mm width

SF-05-50020



Phalangeal Lever

15cm/6"
5mm width

SF-05-50021



Buck-Gramcko Lever

15cm/6"
7.5mm width

SF-05-50022



Mini-Cobra Bone Lever

16cm/6¼"
15mm width

SF-05-50023



McGlamry Metatarsal Elevator

17cm/6½"
Sharp

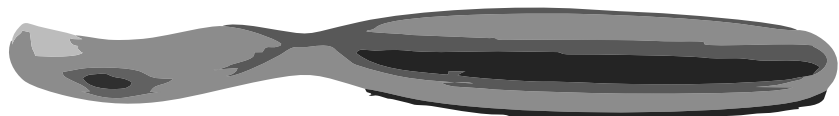

Width

SF-05-50024	9mm
SF-05-50025	11mm
SF-05-50026	13mm
SF-05-50027	15mm
SF-05-50028	19mm

Hohmann Bone Elevator

- 22cm/8½" length
- 8mm width

SF-05-50029



Hohmann Bone Elevator

- 24cm/9½" length
- 18mm width

SF-05-50030



Hohmann Bone Elevator

- 24.5cm/9½" length
- 43mm width

SF-05-50031



- 24cm/9½" length
- 70mm width

SF-05-50032



Hohmann Bone Elevator

- 28cm/11" length
- 33mm width

SF-05-50033



Hohmann Bone Elevator

- 26cm/10" length
- 24mm width

SF-05-50034



Long Curved Hohmann Inferior Hip Elevator

- 40cm/16" length
- 22mm width

SF-05-50035

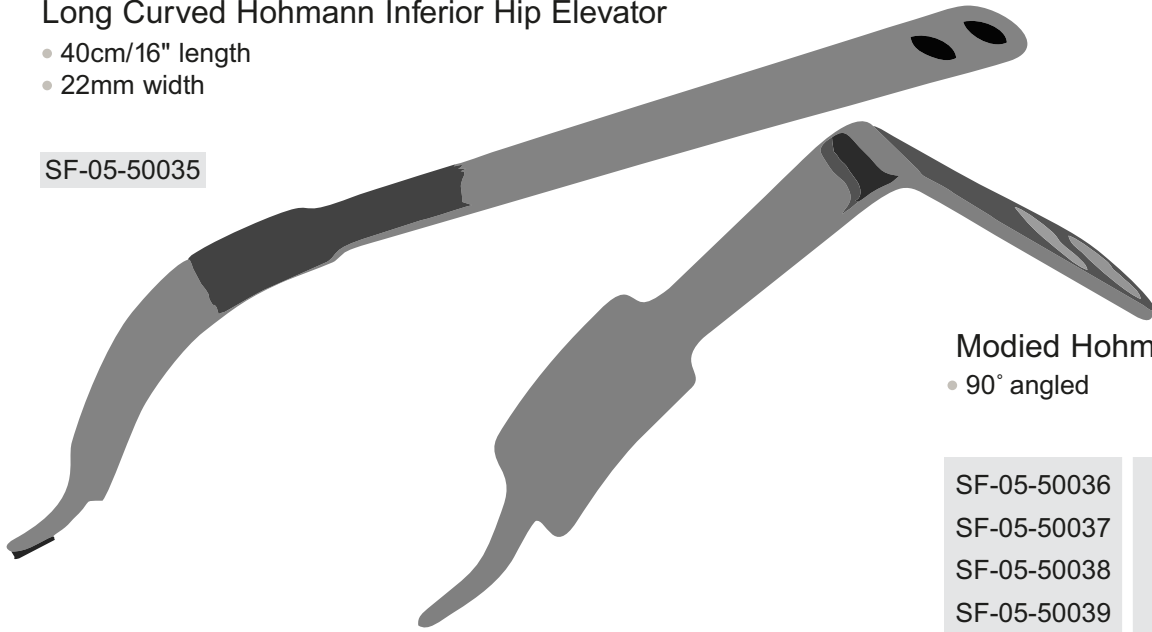

Modied Hohmann Elevator

- 90° angled

Width

SF-05-50036	10mm
SF-05-50037	18mm
SF-05-50038	25mm
SF-05-50039	43mm
SF-05-50040	70mm

Modied Cobra Aufrang Elevator

- 33cm/13" long blade
- 30mm x 100mm

SF-05-50041



Shallow Bone Elevator

- 25cm/9¾" length

SF-05-50042



Concave Moor Elevator

- 33cm/13" long blade

SF-05-50043

Murphy Bone Skid Elevator

- 28cm/11" length
- For dislocation of the femoral head
- Double ended

SF-05-50044



Infero-Posterior Acetabular Capsule Retractor

- 35cm/14" length

Right

SF-05-50045

Left

SF-05-50046

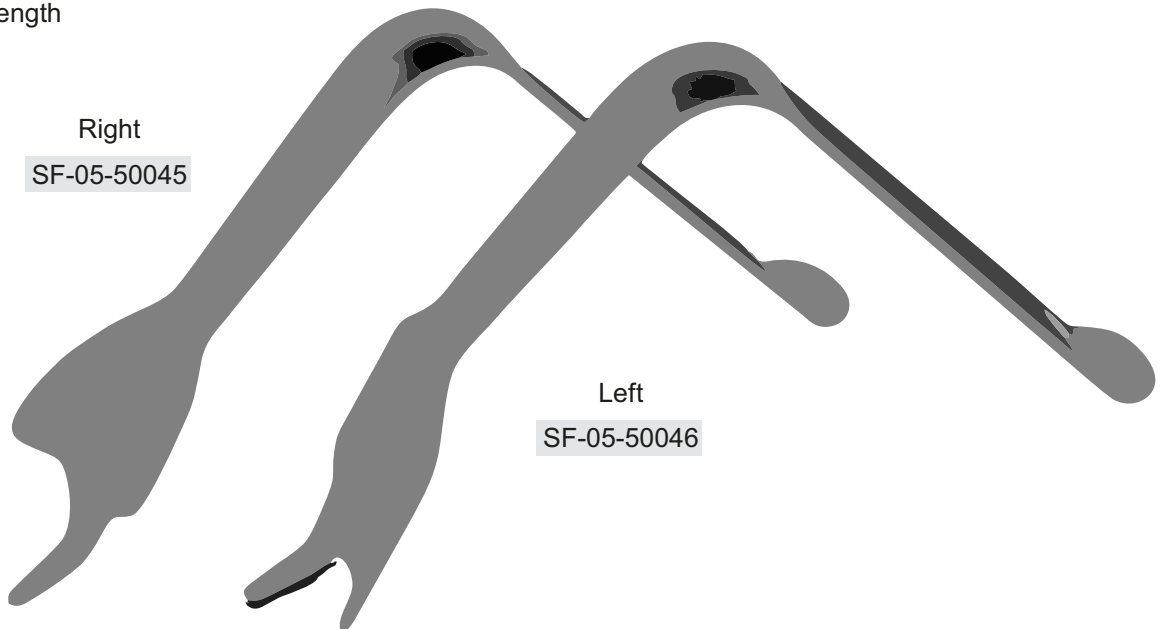

PCL Retractor

- 25cm/10" length
- To straddle the cruciate ligament
- 4mm wide prongs
- 21mm wide tips

SF-05-50047



Wide Prong PCL Retractor

- 25cm/10" length
- To straddle the cruciate ligament
- 5mm wide prongs
- 23mm wide tips

SF-05-50048

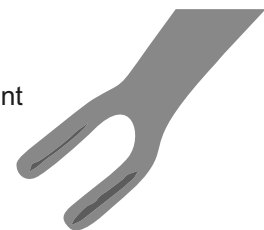

Bone Hook Sharp

- 24.5cm/9¾" length
- Sharp

SF-05-50049

**Blunt Hook**

- 20cm/8" length

SF-05-50050

**Wroblenski Dislocating Hook**

- 25cm/10" length
- For hooking around the neck of the Femur

SF-05-50051

**McMinn Dislocating Hook**

- 25cm/10" length
- Blunt hook with Tufnol handle

SF-05-50052



Scaphoid Spreader - Fine Pattern

14cm/5½" length
1 x 2 prongs

6mm

SF-05-50053



Scaphoid Spreader - Standard Pattern

14cm/5½" length

6mm

SF-05-50054



Baby Inge Bone Spreader

18cm/7" length

7mm
Toothed



SF-05-50055

7mm
Smooth



SF-05-50056

7mm
Cross Serrated



SF-05-50057



Scaglietti Lamina Spreader

28cm/11" length
With speed lock



SF-05-50058



Bohler Bone Cutters

15cm/6" length
Double action

Straight

SF-05-50059

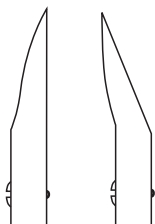

Angled

SF-05-50060



McIndoe Bone Cutters

- 18cm/7" length
- Double action
- Angled jaws



SF-05-50061



Ruskin-Liston Bone Cutters

19cm/7½" length
Double action

Straight

SF-05-50062



SF-05-50063



Stille-Liston Bone Cutters

- 27cm/10¾" length
- Double action

Straight

SF-05-50064



Angled

SF-05-50065



Liston-Key-Horsley Bone Cutters

- 27cm/10¾" length
- Double action
- Angled

SF-05-50066



14cm/4½" length
Curved

2mm Bite

SF-05-50067



Lempert Bone Nibbler

19cm/7½" length
Single action

3mm Bite

SF-05-50068



Luer Bone Nibbler

18cm/7" length
Single action

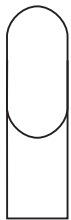

Straight
8mm Bite

SF-05-50069



Curved
8mm Bite

SF-05-50070



Adsons Bone Nibbler

20cm/8" length
Single action



7mm Bite

SF-05-50071



Bohler Bone Nibbler

Curved double action
15cm/6"

3mm Bite

SF-05-50072

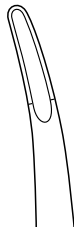

Marquardt Bone Nibbler

- 20cm/8" length
- Curved double action

3mm Bite

SF-05-50073



Beyer Bone Nibbler

Curved double action
18cm/7"

4mm Bite

SF-05-50074

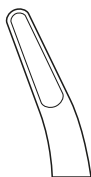

Jansen Bone Nibbler

Curved double action
18cm/7"

5mm Bite

SF-05-50075

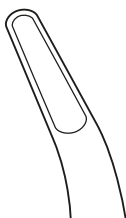

Smith-Peterson Bone Nibbler

- 24cm/9½" length
- Double action

Straight	Light Curve	Bite Size
SF-05-50076	SF-05-50080	3mm
SF-05-50077	SF-05-50081	4mm
SF-05-50078	SF-05-50082	5mm
SF-05-50079	SF-05-50083	6mm

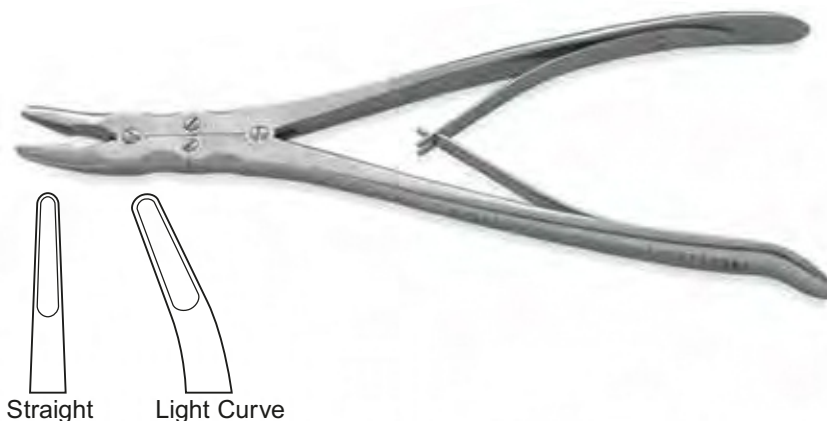

Leksell Bone Nibbler

- 24cm/9½" length
- Double action angled

Angled Jaw	Bite Size
SF-05-50084	3mm
SF-05-50085	5mm
SF-05-50086	8mm

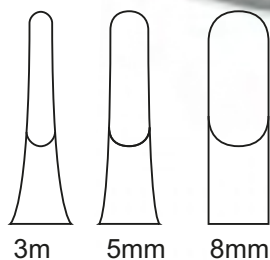

Stille-Luer Bone Nibbler

- 22cm/8¾" length
- Double action

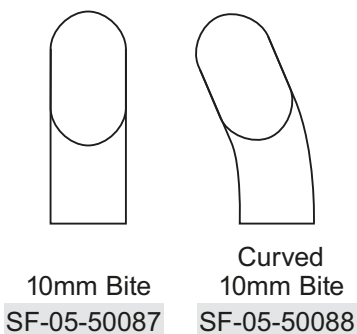

'Mr Blobby' Stille-Luer Bone Nibbler

- 26cm/10¼" length
- Double action

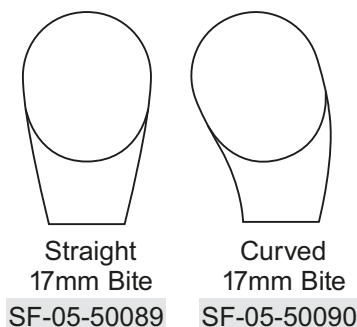

Langenbeck Bone Holding Forceps

- 20cm/8" length

SF-05-50091

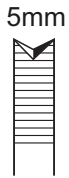

Frosch Bone Holding Forceps

- 18cm/7" length
- Toothed/serrated jaws

SF-05-50092



St. Thomas Bone Holding Forceps

- 18cm/7" length
- ScREW joint

SF-05-50093



Fergusson Bone Holding Forceps

- 20cm/8" length
- ScREW joint

SF-05-50094



Langenbeck Bone Holding Forceps

- 21cm/8¼" length

SF-05-50095



Semb Bone Holding Forceps

- 19cm/7½" length
- Angled to side

SF-05-50096



Hey Groves Bone Holding Forceps

- Screw joints
- Serrated jaws



Length

SF-05-50097	20cm/8"	Small
SF-05-50098	25.5cm/10"	Medium
SF-05-50099	30.5cm/12"	Large

Verbrugge Bone Holding Forceps



Length

SF-05-50100	25cm/10"	Small
SF-05-50101	26cm/10½"	Medium
SF-05-50102	27cm/11"	Large

Pelvic Reduction Forceps

- 19cm/7½" length
- Angled, small
- Pointed ball tips
- Speed lock

SF-05-50103



Pelvic Reduction Forceps

- 23cm/9" length
- Angled, large
- Pointed ball tips
- Speed lock

SF-05-50104



Pelvic Reduction Forceps

- 25cm/10" length
- Straight, large
- Pointed ball tips
- Speed lock

SF-05-50105



Pelvic Reduction Forceps

- 40cm/16" length
- Pointed ball tips
- Speed lock

SF-05-50106



Pelvic Reduction Forceps

- 40cm/16" length
- 3 pointed ball tips
- Speed lock

SF-05-50107



Meyerding Retractor

- 22cm/9" length



Blade size

SF-05-50108	50mm x 16mm
SF-05-50109	70mm x 25mm
SF-05-50110	90mm x 50mm

Langenbeck Retractor

- 21.5cm/8½" length

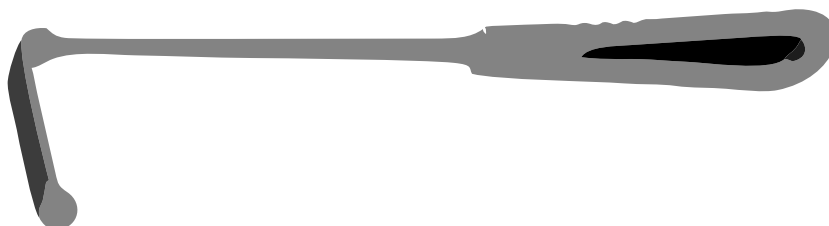

Bladesize

SF-05-50111	22mm x 6mm	Small
SF-05-50112	45mm x 13mm	Medium
SF-05-50113	65mm x 25mm	Large
SF-05-50114	90mm x 20mm	Extra large

Volkman Cataspaw Retractor

- 21.5cm/8½" length
- Semi sharp teeth

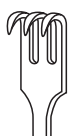

15 x 15mm
3 Prong
SF-05-50115



15 x 20mm
4 Prong
SF-05-50116

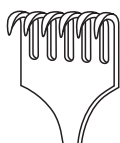

15 x 30mm
6 Prong
SF-05-50117

Charnley Initial Incision Retractor Set

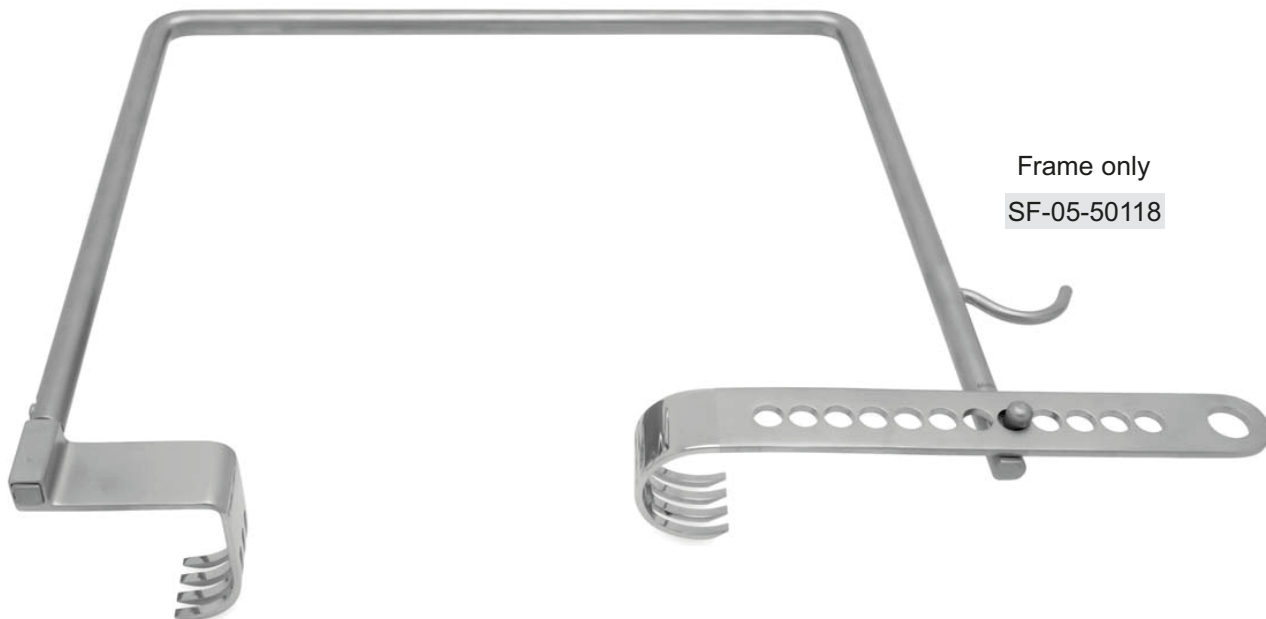

Frame only
SF-05-50118

SF-05-50119 Complete Set -Basic

Consisting of:

- 1x Frame
- 1x Weight & chain
- 1x Square fitting blade - 50mm depth
- 1x Round fitting blade - 40mm depth

SF-05-50120 Complete Set -Extended

Consisting of:

- 1x Frame
- 1x Weight & chain
- 3x Square fitting blades:
 - 50mm depth
 - 75mm depth
 - 100mm depth
- 3x Round fitting blades:
 - 40mm depth
 - 75mm depth
 - 100mm depth

To spread the incision in the fascia lata. It is combined with a weight and chain, which tilts the retractor to an angle of 45° to improve exposure of the anterior aspect of the joint.



Weight & chain
SF-05-50124

Blade with Square Fitting



- SF-05-50121 Standard depth 50mm
- SF-05-50122 Extra depth 75mm
- SF-05-50123 Extra, extra depth 100mm

Blade with Round Fitting

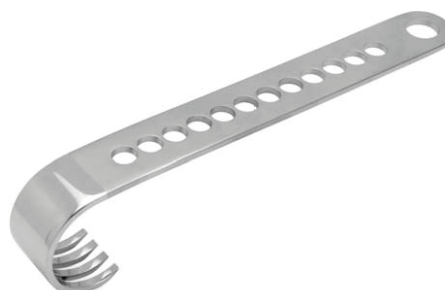

- SF-05-50125 Standard depth 40mm
- SF-05-50126 Extra depth 75mm
- SF-05-50127 Extra, extra depth 100mm

West's S/R Retractor

- 14cm/5½" length
- 3x4 Sharp prongs

SF-05-50128



Weitlaner S/R Retractor

- 14cm/5½" length
- 3x4 Blunt prongs

SF-05-50129



Travers S/R Retractor

- 20cm/8" length
- 4x5 Blunt prongs

SF-05-50130



Norfolk and Norwich S/R Retractor

- 20cm/8" length
- 4x5 Blunt prongs

SF-05-50131



Gelpi Laminectomy Retractor

- Sharp prongs

	Length	Prong depth
SF-05-50132	18.5cm/7¼"	30mm
SF-05-50133	19.5cm/7¾"	50mm
SF-05-50134	20cm/8"	70mm

Charnley Vertical Retractor

- 24.5cm/9½" length
- 3x4 Sharp prongs
- Blade depth 22mm

SF-05-50135



Cones Self Retaining Retractor

- 3x4 Prongs
- Jointed arms



Blunt Prongs	Length	Depth	Sharp Prongs	Length	Depth
SF-05-50136	13cm/5"	15mm	SF-05-50140	13cm/5"	15mm
SF-05-50137	16cm/6 ½"	15mm	SF-05-50141	16cm/6 ½"	15mm
SF-05-50138	20cm/8"	20mm	SF-05-50142	20cm/8"	20mm
SF-05-50139	24cm/9 ½"	25mm	SF-05-50143	24cm/9 ½"	25mm

Harvey Jackson Self Retaining Retractor

- 30.5cm/12" length
- Blade depth 45mm
- 3x3 Sharp prongs

SF-05-50144



Charnley Horizontal Hip Retractor

- 28cm/11" length
- Blade depth 18mm
- Hinged joint
- 7" opening

SF-05-50145

To retract the detached trochanter headwards, and the femur towards the feet



Hardinge Horizontal Retractor

- Blade depth 18mm
- Hinged joint

SF-05-50146



Charnley Pin Retractor

Complete set with:

- T-handle introducer
- Pair of pins with chains

SF-05-50147



SF-05-50148 T-handle only



SF-05-50149 Pair of pins with chain only

One pin, or sometimes two, is driven into the bone of the superior lip of the acetabulum, to stake back the capsule to give a clear view of the superior lip of the acetabulum. The nerve supply to the tensor fasciae femoris is preserved in this exposure by restricting dissection in the cleft in front of the gluteus medius, but this restricts exposure. By using pins to stake back the abductor muscles, a good exposure of the acetabulum can be obtained, and at the same time the nerve supply to tensor fasciae femoris can be preserved.

The short pins do not obstruct the surgeon's hand in access to the acetabulum. The chain is a safety device to prevent the pins being left in situ.

Viper Hinged Scoliosis Retractor

- 30cm/11¾" length
- Sharp

	Depth Prongs
SF-05-50150	40mm
SF-05-50151	70mm
SF-05-50152	100mm

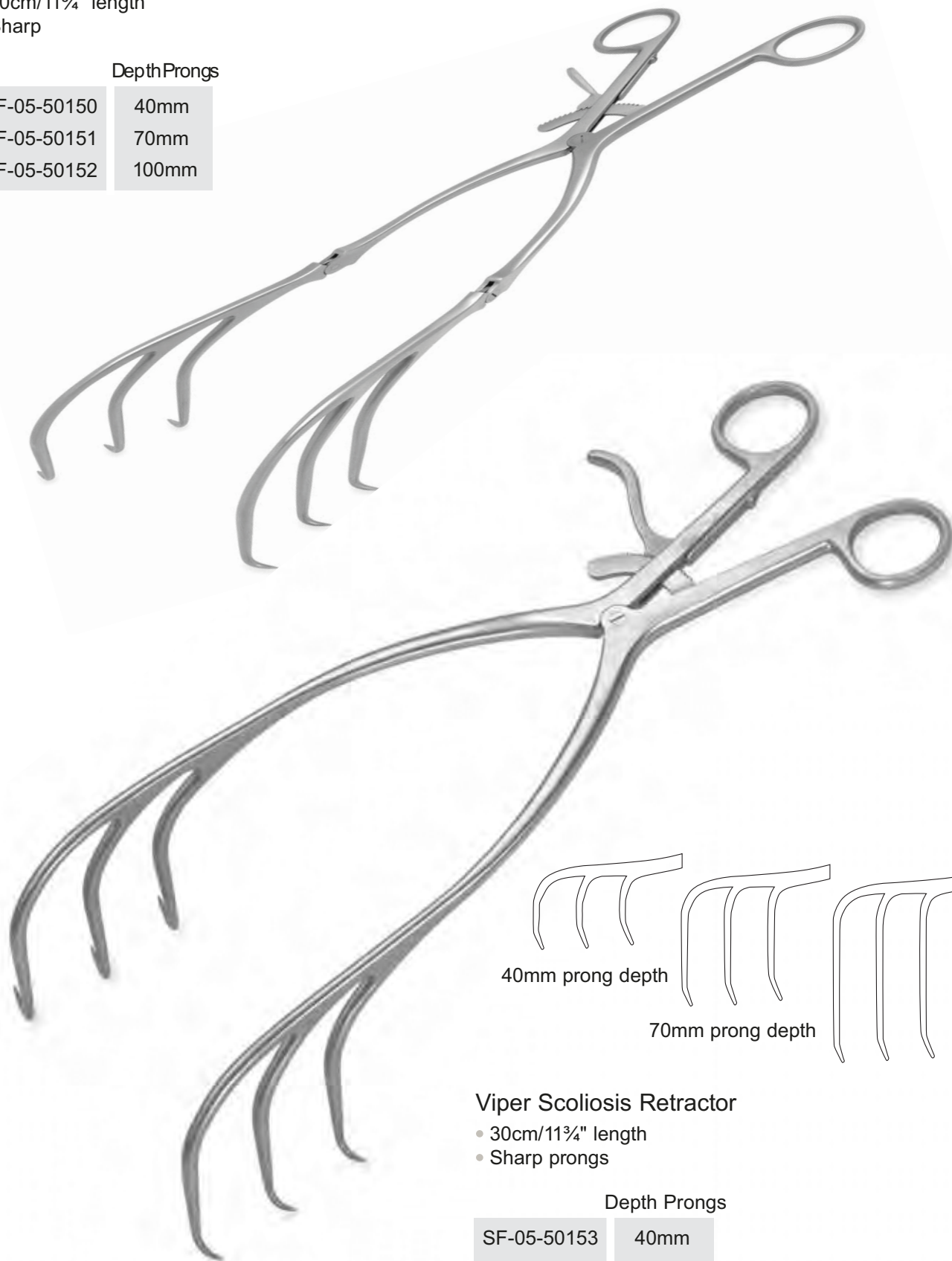

40mm prong depth

70mm prong depth

Viper Scoliosis Retractor

- 30cm/11¾" length
- Sharp prongs

	Depth Prongs
SF-05-50153	40mm
SF-05-50154	70mm
SF-05-50155	100mm

19cm/7½" length
Head size 22mm Ø
Weight 165g/6oz



SF-05-50156

Ultra Fine Mallet

- 17cm/6¾" length
- Head size 20mm Ø
- Weight 145g/5oz



SF-05-50157

Heath Mallet

19cm/7" length
Stainless steel head
Head size 40mm Ø
Weight 1020g/36oz



SF-05-50158

Mallet with Tufnol Handle

23cm/9" length
Small head size 30mm Ø
Weight 350g/12oz

SF-05-50159

Medium head size 35mm Ø
Weight 550g/20oz

SF-05-50160

Large head size 40mm Ø
Weight 700g/25oz

SF-05-50161



London Splint Mallet

- 18cm/7" length
- Head size 30mm Ø
- Weight 450g/16.2oz

SF-05-50162



Ombredanne Mallet

- 24cm/9½" length
- Head size 40mm Ø
- Weight 550g/20oz

SF-05-50163



Mallet with Tufnol Handle

- 24cm/9½" length
- Lead lled head
- Weight 400g/14oz

SF-05-50164



Tufnol Mallet

- 25.5cm/10" length
- Head size 42mm Ø
- Weight 250g/10oz

SF-05-50165



Mini-Lambotte Osteotome

12.5cm/5" length



	Width
SF-05-50166	2mm
SF-05-50167	3mm
SF-05-50168	4mm
SF-05-50169	6mm
SF-05-50170	8mm

Set of 5 sizes:
2mm to 8mm

SF-05-50198

Lambotte Osteotome

25cm/9¾" length



Straight	Width
SF-05-50171	4mm
SF-05-50172	6mm
SF-05-50173	8mm
SF-05-50174	10mm
SF-05-50175	13mm
SF-05-50176	16mm
SF-05-50177	18mm
SF-05-50178	20mm
SF-05-50179	25mm
SF-05-50180	30mm

Curved	Width
SF-05-50181	4mm
SF-05-50182	6mm
SF-05-50183	8mm
SF-05-50184	10mm
SF-05-50185	13mm
SF-05-50186	16mm
SF-05-50187	18mm
SF-05-50188	20mm
SF-05-50189	25mm
SF-05-50190	30mm

Ultra Fine Osteotome (Titanium Nitrate Coated)

16cm/6¼" length



	Width
SF-05-50191	2mm
SF-05-50192	4mm
SF-05-50193	6mm
SF-05-50194	8mm
SF-05-50195	10mm
SF-05-50196	12mm

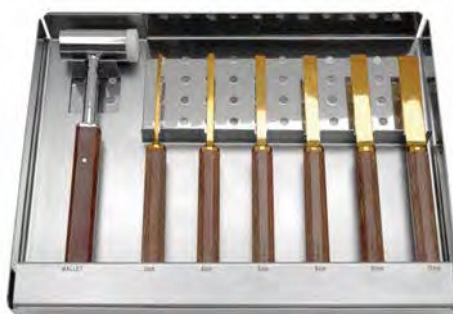

Set of 6 sizes: 2mm to 12mm
complete with mallet in
sterilising case

SF-05-50197

Mini- Stille Osteotome

16cm/6¼" length



Straight	Width
SF-05-50199	4mm
SF-05-50200	6mm
SF-05-50201	8mm

Stille (Swedish) Osteotome

• 20cm/8" length



Straight	Width
SF-05-50202	6mm
SF-05-50203	8mm
SF-05-50204	10mm
SF-05-50205	12mm
SF-05-50206	15mm
SF-05-50207	20mm
SF-05-50208	25mm
SF-05-50209	30mm

Hibbs Osteotome with thin blade

- 20cm/8" length
- Extra thin blade



Straight	Width	Curved	Width
SF-05-50210	4mm	SF-05-50219	4mm
SF-05-50211	6mm	SF-05-50220	6mm
SF-05-50212	8mm	SF-05-50221	8mm
SF-05-50213	10mm	SF-05-50222	10mm
SF-05-50214	12mm	SF-05-50223	12mm
SF-05-50215	15mm	SF-05-50224	15mm
SF-05-50216	20mm	SF-05-50225	20mm
SF-05-50217	25mm	SF-05-50226	25mm
SF-05-50218	30mm	SF-05-50227	30mm

Smith Petersen Osteotome

• 20cm/8" length



	Width
SF-05-50228	10mm
SF-05-50229	15mm
SF-05-50230	20mm
SF-05-50231	25mm
SF-05-50232	30mm

Mini-Lexer Osteotome

- 18cm/7" length
- Tufnol handle

SF-05-50233 Set of 5 sizes:
2mm to 10mm



	Width
SF-05-50234	2mm
SF-05-50235	4mm
SF-05-50236	6mm
SF-05-50237	8mm
SF-05-50238	10mm

Lexer Osteotome

- 22cm/8½" length
- Tufnol handle



	Width
SF-05-50239	7mm
SF-05-50240	10mm
SF-05-50241	15mm
SF-05-50242	20mm
SF-05-50243	25mm

Dahmen Osteotome

- 30cm/12" length
- Tufnol handle



	5mm
	10mm
	15mm
	20mm
	25mm
	30mm

	Straight	Width
	SF-05-50244	5mm
	SF-05-50245	10mm
	SF-05-50246	15mm
	SF-05-50247	20mm
	SF-05-50248	25mm
	SF-05-50249	30mm

	Angled	Width
	SF-05-50250	5mm
	SF-05-50251	10mm
	SF-05-50252	15mm
	SF-05-50253	20mm
	SF-05-50254	25mm
	SF-05-50255	30mm

Box Chisel

29cm/13½" length
 For preparation of the proximal femur
 31mm width x 6mm

SF-05-50256



Pelvic Osteotome

- 30cm/12" length
- Tufnol handle
- Angled shaft

15mm width 20mm width
 SF-05-50257 SF-05-50258



Chisel with Interchangeable Blades

- 20cm/8" length
- Tufnol handle
- Very thin blades

SF-05-50259

Complete set with 4 blades & key



Blade Width

SF-05-50260	5mm
SF-05-50261	8mm
SF-05-50262	10mm
SF-05-50263	12mm
SF-05-50264	15mm
SF-05-50265	25mm

Capener Lamina Gouge

- 23cm/9" length
- Cranked shaft

	Width
SF-05-50266	6mm
SF-05-50267	8mm
SF-05-50268	11mm
SF-05-50269	16mm



Volkman Curette

- 22cm/8¾" length
- Double ended

	Size
SF-05-50270	Small
SF-05-50271	Medium
SF-05-50272	Large

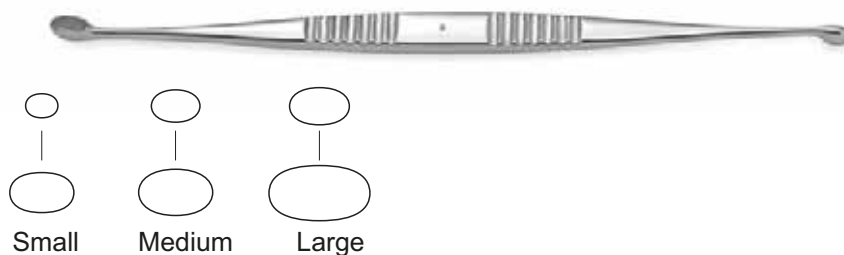

Muller Curette with Tufnol Handle

- 27cm/9¾" length
- Tufnol handle



Small cup 9mmØ
SF-05-50273

Medium cup 13mm Ø
SF-05-50274

Large cup 27mm Ø
SF-05-50275
24cm length

Charnley Bone Curette

- 37cm/15" length
- T-handle



Small cup 14mm Ø
SF-05-50276

Medium cup 17mm Ø
SF-05-50277

Large cup 22mm Ø
SF-05-50278

Charnley Ring Curette

- 37cm/15" length
- Double sided
- Serrated cutting edge
- T-handle



SF-05-50279

Cup Extraction Chisel

- 32cm/12½" length
- Curved 7mm tip
- Metal strike plate
- Tufnol handle



SF-05-50280

Bayonet Gouge

- 32cm/12½" length
- Metal strike plate
- Tufnol handle
- 8mm width



SF-05-50281

Swan Necked Gouge

- 28.5cm/11" length
- 25mm width



SF-05-50282

Cement Gouge

- 34.5cm/13½" length



9mm width
SF-05-50283

11mm width
SF-05-50284

Cement Chisel Angled 15°

- 35.5cm/14 length
- 9mm tip



SF-05-50285

Cement Osteotome

- 30cm/12" length
- Tufnol handle with strike plate



Cement Splitting Osteotome

- 30cm/12" length
- Tufnol handle with strike plate
- Guarded blade



Straight Cement Gouge

- 30cm/12" length
- Tufnol handle with strike plate



Bayonet Cement Rasp

- 52cm/20½" length
- Tufnol handle



Bayonet Cement Chisel

- 40cm/15¾" length
- Tufnol handle with strike plate



Bayonet Cement Splitting Osteotome

- 40cm/15¾" length
- Tufnol handle with strike plate
- Guarded blade



Bayonet Cement Gouge

- 40cm/15¾" length
- Tufnol handle with strike plate



Bayonet Cement Gouge

- 40cm/15¾" length
- Tufnol handle with strike plate

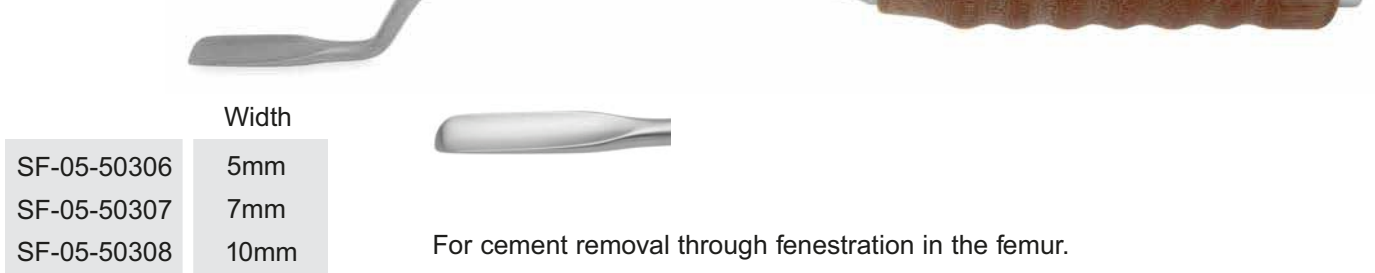

Malleable Cement Probe

- 38cm/15" length
- For probing the Femur



SF-05-50309

Cement Plug Extractor

- 48cm/19" length
- T-handle
- For extraction of cement plug



ThreadDia.

SF-05-50310	7mm
SF-05-50311	9mm
SF-05-50312	11mm



Used with a slotted mallet

Retrograde Cement Chisel

- 50cm/19¾" length
- Tufnol T-handle
- Striking plate



Width

SF-05-50313	5mm
SF-05-50314	7mm
SF-05-50315	10mm



Slotted Mallet

SF-05-50316



Cement Extraction Hook

- 34.5cm/14" length

SF-05-50317

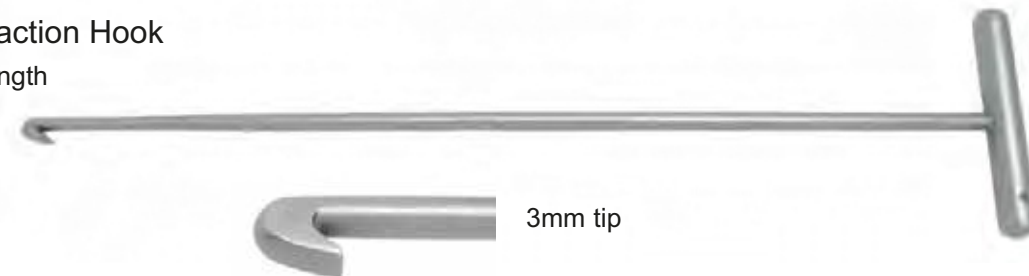

3mm tip

Cement Twist Drill Long

- 40cm/15¾" length



Diameter

SF-05-50318	6mm
SF-05-50319	8mm
SF-05-50320	10mm

Fine Cement Duckbill Grasping Forceps

- 35cm/14" shaft length
- Fine jaws

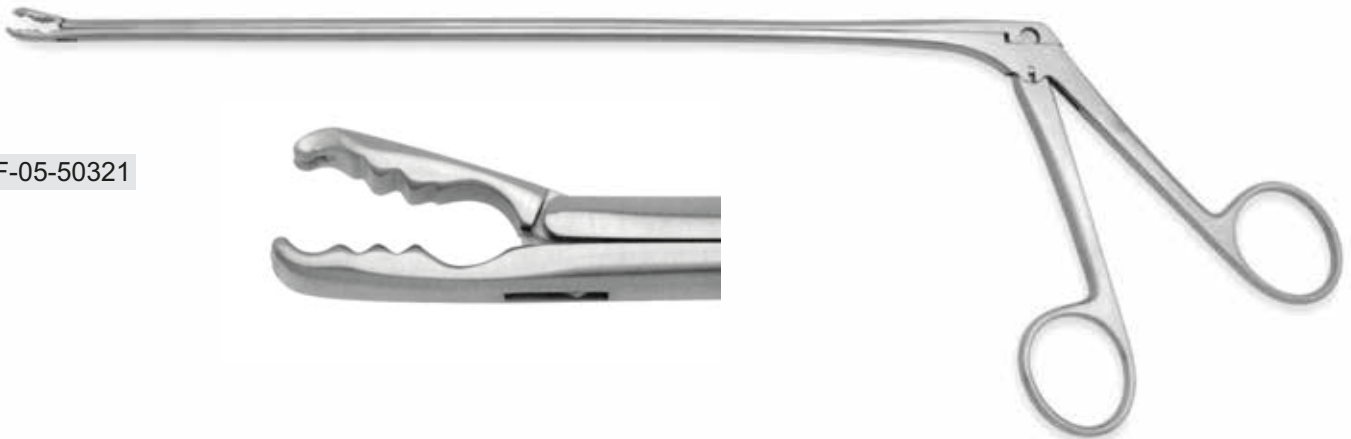

SF-05-50321

Heavy Cement Grasping Forceps

- 26cm/10" shaft length
- Serrated jaws 6mm width



SF-05-50322

Femoral Head Extractor

- 23cm/9" length
- Tufnol handle

SF-05-50323



Moore Femoral Head Extractor

- 20.5cm/8" length
- Metal handle

SF-05-50324



Joint Capsule Clamp

- 21cm/8¼" length
- 25mm jaw length

SF-05-50325



Joint Capsule Scissors

- 25cm/9¾" length
- Angled blades

SF-05-50326



Femoral Head Impactor

- 20cm/8" length
- Nylon head

SF-05-50327



McGoey Bone Punch

- Double ended

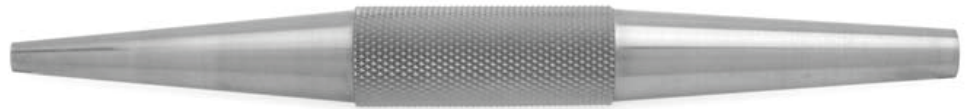

illustrated

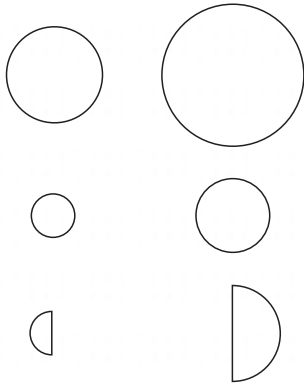

No 1. 13mm x 19mm Ø SF-05-50328 Large size

No 2. 6mm x 10mm Ø SF-05-50329 Small size

No 3. 6mm x 13mm Ø SF-05-50330
With ats

Hardinge Cement Restrictor

- 33.5cm/13³/₄" length
- Graduated shaft



SF-05-50331

Femoral Pusher

- Square ended

SF-05-50332



Universal Fine Pliers and Cutters

- 15cm/6" length

SF-05-50333

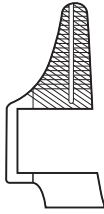

Slim & Square Ended Wire Pliers

- 19cm/7½" length

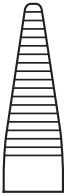

Slim Nose

SF-05-50334

Serrated jaw

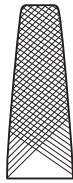

Square Ended

SF-05-50335



illustrated

Pliers for Screw Removal

- 20cm/8" length

SF-05-50336



Muller Claus Wire Pullers

- 18cm/7" length
- Double action
- Tungsten jaws

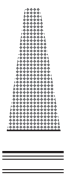

2mm Jaws

SF-05-50337

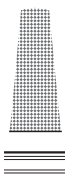

4mm Jaws

SF-05-50338



6mm Jaws

SF-05-50339



Muller Claus Wire Cutters

- 16cm/6" length
- Tungsten carbide edges
- Cuts wire up to 1.6mm Ø

SF-05-50340



Muller Claus Wire Cutters

- Tungsten carbide edges

SF-05-50341

- 18cm/7" length
- Cuts wire up to 2mm Ø

SF-05-50342

- 22cm/8¾" length
- Cuts wire up to 3mm Ø



illustrated

End Wire Cutters

- 18cm/7" length
- Tungsten carbide edges
- Cuts wire up to 1.7mm Ø

SF-05-50343



Bolt Cutters with dismantable arms

- Max. cap 6.3mm pins

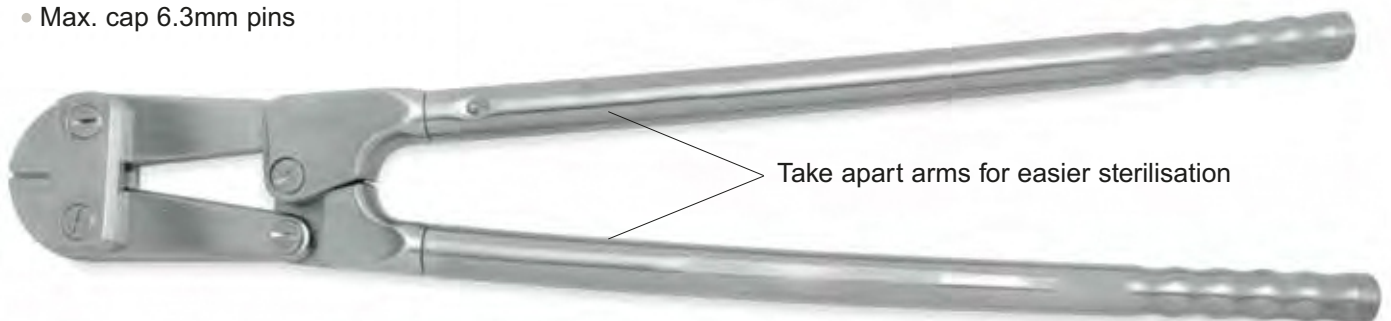

SF-05-50344

- Must be used in conjunction with a Rod Holder. Ordering Code: 200-675-200

Combined Wire Cutters & Pliers

- 18cm/7" length
- Suitable for wires up to 1.6mm Ø
- Parallel closing jaws

SF-05-50345



Wire Cutters with T/C Jaws

- 24cm/9½" length
- Double action
- Cuts plates & wires up to 2.7mm Ø

SF-05-50346



'Power Cut' Wire Cutters

- 20cm/8" length
- Cutting inserts are T/C and can be replaced
- Cuts wires up to 3mm Ø

SF-05-50347



Needle Nosed Locking Pliers



Code	Length	
SF-05-50348	22cm/8¾"	Small
SF-05-50349	25cm/9¾"	Medium
SF-05-50350	30cm/11¾"	Large

- A very useful instrument for orthopaedic surgery allowing the surgeon to securely clamp on to wires and implants.



Slap Hammer attachment combined

Code	Length	Weight
SF-05-50351	35cm/13¾"	400g
SF-05-50352	35cm/13¾"	700g

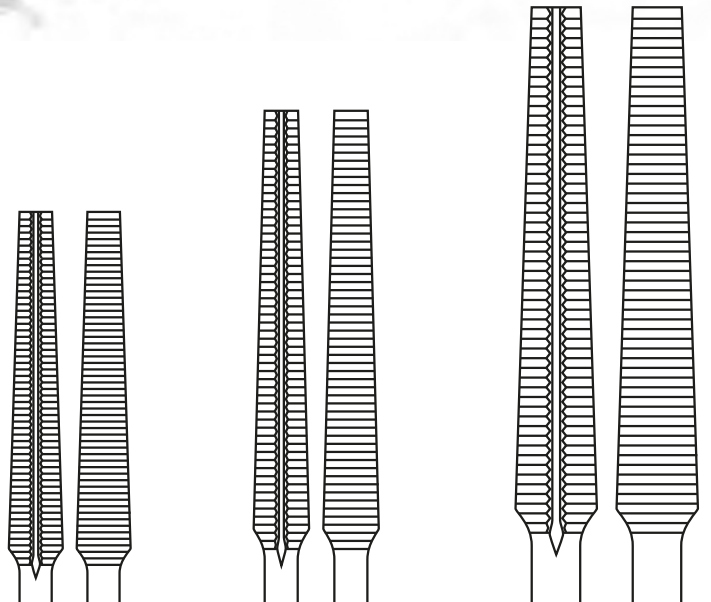

22cm/8¾" Small 25cm/9¾" Medium 30cm/11¾" Large

Orthopaedic Locking Pliers

- Hardened jaws



Code	Length	
SF-05-50353	18cm/7"	Small
SF-05-50354	20cm/8"	Medium
SF-05-50355	24cm/9½"	Large

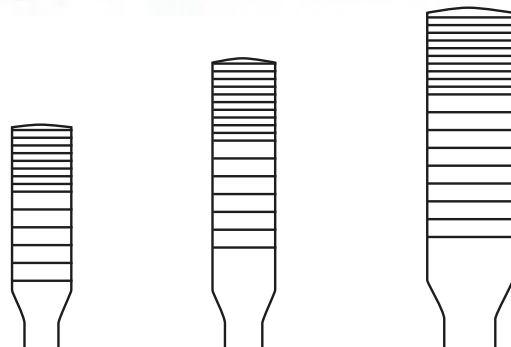

18cm/7" Small 20cm/8" Medium 24cm/9½" Large

Kirschner Wire Introducing T-Handle

- 12cm/4¾" length
- 1.5mm Ø wires

SF-05-50356



Steinmann Pin Introducer T-Handle

- 14cm/5½" length
- 0.5mm - 8mm Ø pins
- With Jacobs chuck & key

SF-05-50357

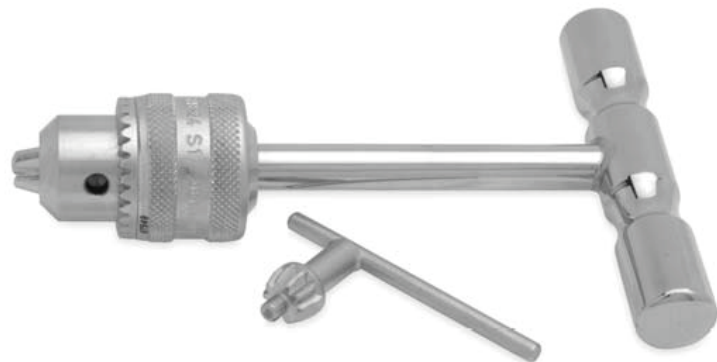

Steinmann Pin Introducer T-Handle

- 14cm/5½" length
- 0.7mm - 6mm Ø pins
- Universal chuck

SF-05-50358



Bone Mill

- Table mounted with crank handle
- With removable cutting drum

SF-05-50359

For grinding bone chips used for bone graft procedures.

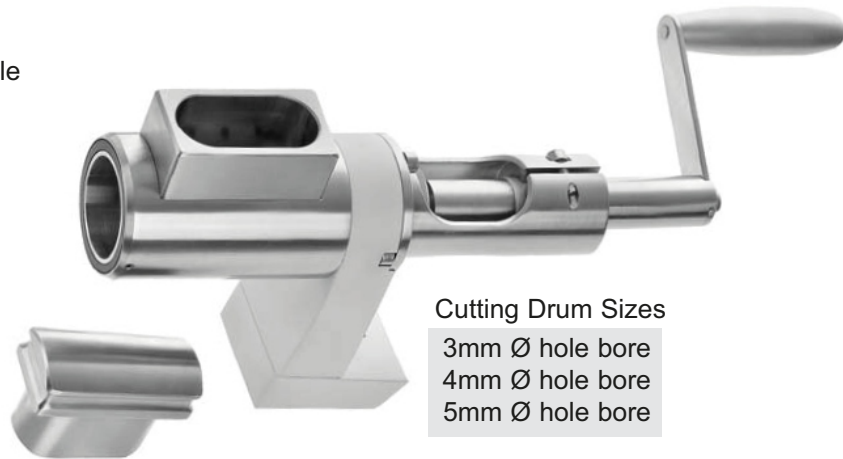

Cutting Drum Sizes

- 3mm Ø hole bore
- 4mm Ø hole bore
- 5mm Ø hole bore

Wire Passing Guide

- 21cm/8¼" length

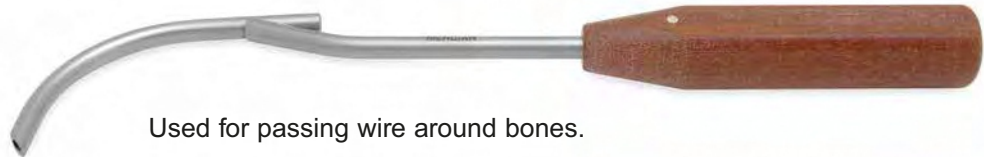

Used for passing wire around bones.

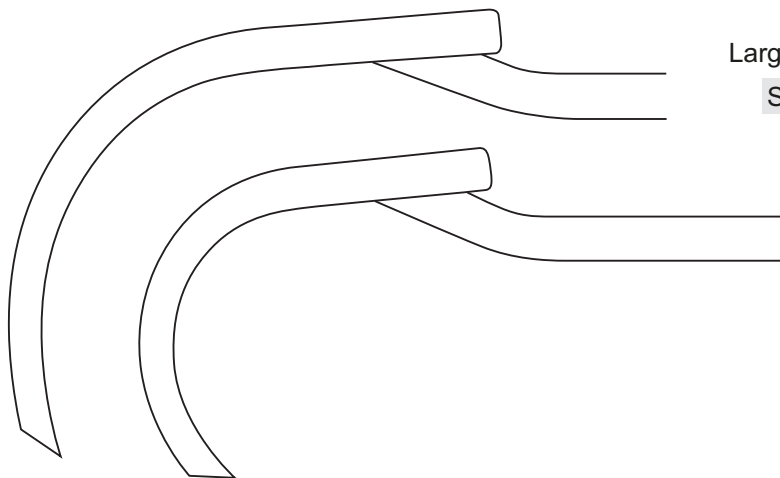

Large curve 70mm Ø

SF-05-50360

Small curve 45mm Ø

SF-05-50361

Bone Awl

- Straight with eye



	Diameter	Length
SF-05-50362	2.0mm	125mm
SF-05-50363	2.4mm	130mm
SF-05-50364	2.8mm	145mm
SF-05-50365	3.2mm	160mm
SF-05-50366	3.6mm	165mm
SF-05-50367	4.0mm	175mm

Slotted Head

- 17cm/6¾" length
- For head screws 2.7mm - 4.0mm

SF-05-50368

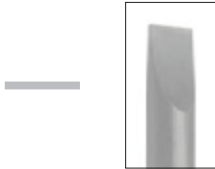

Long Slotted Head

- 25cm/10" length
- For head screws 2.7mm - 4.0mm

SF-05-50369



Phillips Head

- 25cm/10" length
- For small Phillips head screws 6mm

SF-05-50370

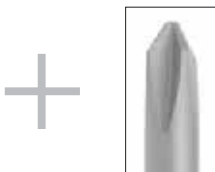

Cross Slotted Head

- 25cm/10" length
- For cross slot screws 6mm

SF-05-50371

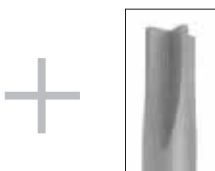

Hexagonal Head

- 25cm/10" length
- For hexagonal head screws 2.7mm - 4.0mm



2.5mm Hex
SF-05-50372



3.5mm Hex
SF-05-50373

For 2.7mm to 3.5mm screws For 4.5mm to 6.5mm screws

Screwdriver Handle

- To fit shafts with quick lock attachment

SF-05-50374



Screwdriver Handle Small

- To fit shafts with quick lock attachment

SF-05-50375



Shaft with Quick Lock Fitting

- Hexagonal tip



Shaft	Diameter
SF-05-50376	2.5mm
SF-05-50377	3.5mm

Howarth Elevator

- 21.5cm/8½" length



SF-05-50378

MacDonald Elevator/Dissector



Size

SF-05-50379	19cm/7 ½"
SF-05-50380	23cm/9"

Watson Cheyne Dissector



Length

SF-05-50381	18cm/7"
SF-05-50382	23cm/9"
SF-05-50383	25.5cm/10"

Freers Elevator/Dissector

- 18.5cm/7¼" length



SF-05-50384

Swedish Dissector

- 18cm/7" length



SF-05-50385

Stainless Steel Measuring Ruler

Code	Length
SF-05-50386	15cm/6"
SF-05-50387	30cm/12"



Measuring Caliper

- 25cm/10" length
- Measuring range \varnothing -50mm

SF-05-50388



Vernier Caliper

- 22.5cm/9" length
- Measuring range 15cm

SF-05-50389

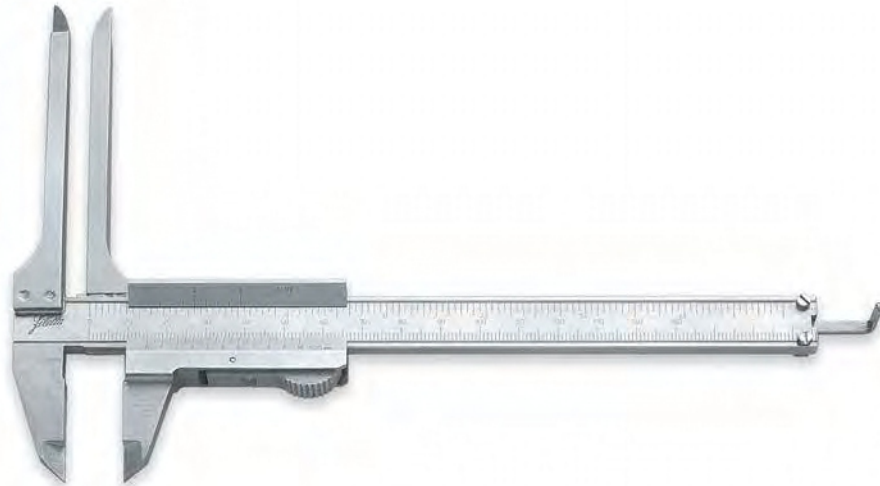

Depth Gauge

- Measuring depth up to 50mm

SF-05-50390



Depth Gauge

- Measuring depth up to 70mm

SF-05-50391



Direct Reading Depth Gauge

- 23cm length
- Measuring depth up to 40mm

SF-05-50392



Shoulder Surgery Instruments

Penetrating Bone Gouge

- 22cm/8 3/4" length
- 3mm wide tip

SF-05-50393



Percussion Bone Awl

- 22cm/8 3/4" length
- Curved, with metal handle

SF-05-50394



Penetrating Bone Awl

- 18cm/7" length
- Tufnol handle

SF-05-50395



Crochet Hook Suture Passer

- 18cm/7" length
- Tufnol handle

SF-05-50396



Suture Passer

- 18/7"cm length
- Tufnol handle
- With hole in tip

SF-05-50397

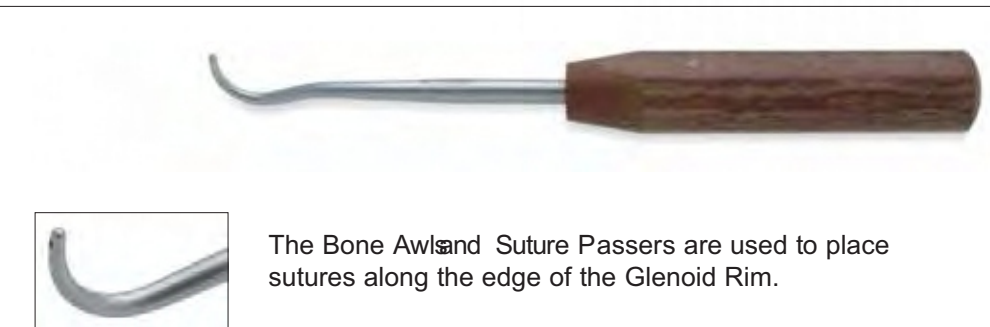

The Bone Awl and Suture Passers are used to place sutures along the edge of the Glenoid Rim.

Glenoid Perforating Forceps Light Curve

- 17cm/6³/₄" length
- Light curve

SF-05-50398

For perforating holes in the Glenoid Rim.



Glenoid Perforating Forceps Strong Curve

- 17cm/6³/₄" length
- Strong curve

SF-05-50399



Kolbel Glenoid Elevator

- 30cm/12" length
- 15mm width
- Curved
- Double prong

SF-05-50400



Kolbel Glenoid Elevator

- 30cm/12" length
- 20mm width
- Curved
- Double prong

SF-05-50401



Posterior Glenoid Elevators

- Curved tip to sit on posterior rim of Glenoid
- For Posterior Retraction of the Humeral Head



	Width tip
SF-05-50402	8mm
SF-05-50403	12mm
SF-05-50404	20mm

Skid Lever

- 28cm/11" length
- Double ended
- 20mm and 30mm blade widths

SF-05-50405



Humerus Head Retractor

- 18cm/7" length
- Strongly curved
- Double blunt prongs

SF-05-50406



Bhattman Humerus Head Retractor

- 25cm/9 3/4" length
- 30mm width
- Double prong

SF-05-50407



Fukuda Humerus Head Retractor

- 22.5cm/9" length
- Fenestrated

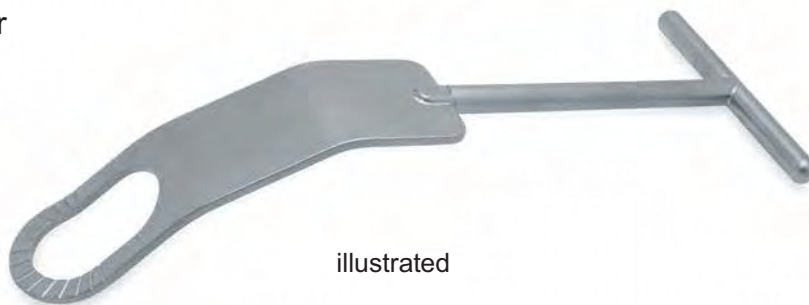

illustrated

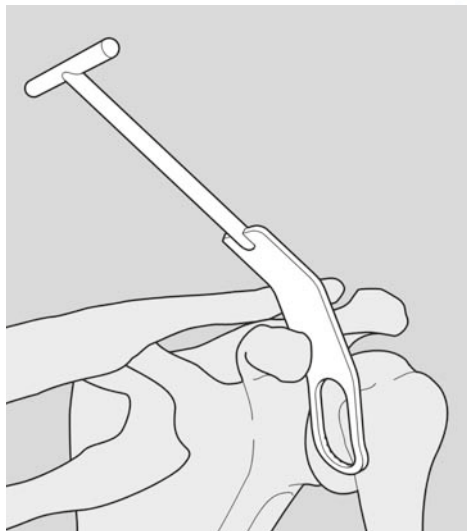

	width
SF-05-50408	32mm
SF-05-50409	35mm*
SF-05-50410	37mm

Darrach Acromial Elevators



illustrated

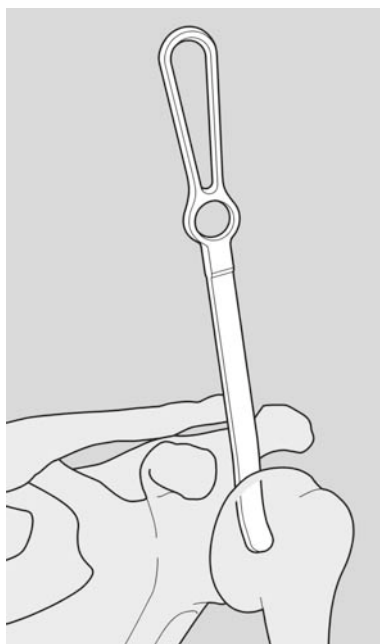

Small 9mm width, 26cm/10³/₄" length

SF-05-50411



Medium 12mm width, 26cm/10³/₄" length

SF-05-50412



Large 16mm width, 26cm/10³/₄" length

SF-05-50413



Extra Large 25mm width, 36cm/14³/₄" length

SF-05-50414

Set of 4 Elevators SF-05-50415

Subacromion Spreader

- 19cm/7 1/2" length
- Small size

SF-05-50416 left side ring

SF-05-50417 right side ring



illustrated

Subacromion Spreader

- 25cm/9 3/4" length
- Large size

SF-05-50418 left side ring

SF-05-50419 right side ring



illustrated

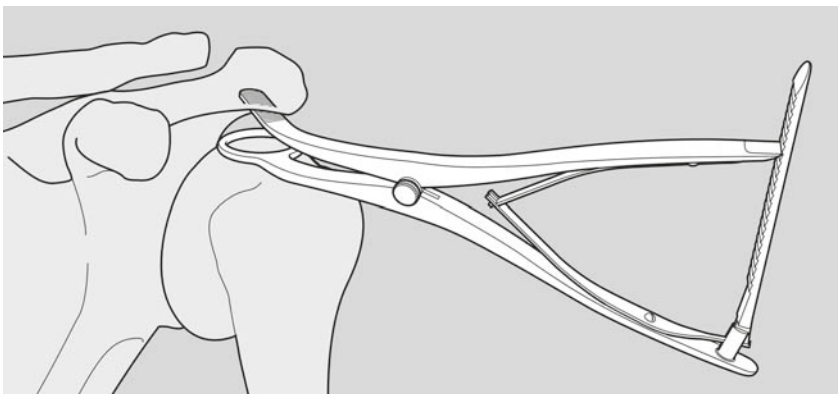

These spreaders are used when access is required to the subacromion area. The spreaders distract the humeral head from the acromion.

Kolbel Tissue & Muscle Spreader

- 18cm/7" length
- Straight single blunt prongs

SF-05-50420



Kolbel Tissue & Muscle Spreader

- 18cm/7" length
- Angled single blunt prongs

SF-05-50421



Kolbel Tissue & Muscle Spreader

- 18cm/7" length
- Angled double blunt prongs

SF-05-50422



Capsule Spreader

- 18cm/7" length
- Single blunt prongs
- 90° Angled

SF-05-50423



Kolbel Shoulder Retractor

- With 3 pairs of detachable blades
- 23cm/9" length

SF-05-50424

Complete set with 3 pairs of blades and retractor frame



SF-05-50425

Retractor frame only



SF-05-50426
Small blade



SF-05-50427
Medium blade



SF-05-50428
Large blade

Browne Deltoid Retractor

- 27cm/10 1/2" length
- 60mm x 65mm blade
- Cupped blade

SF-05-50429

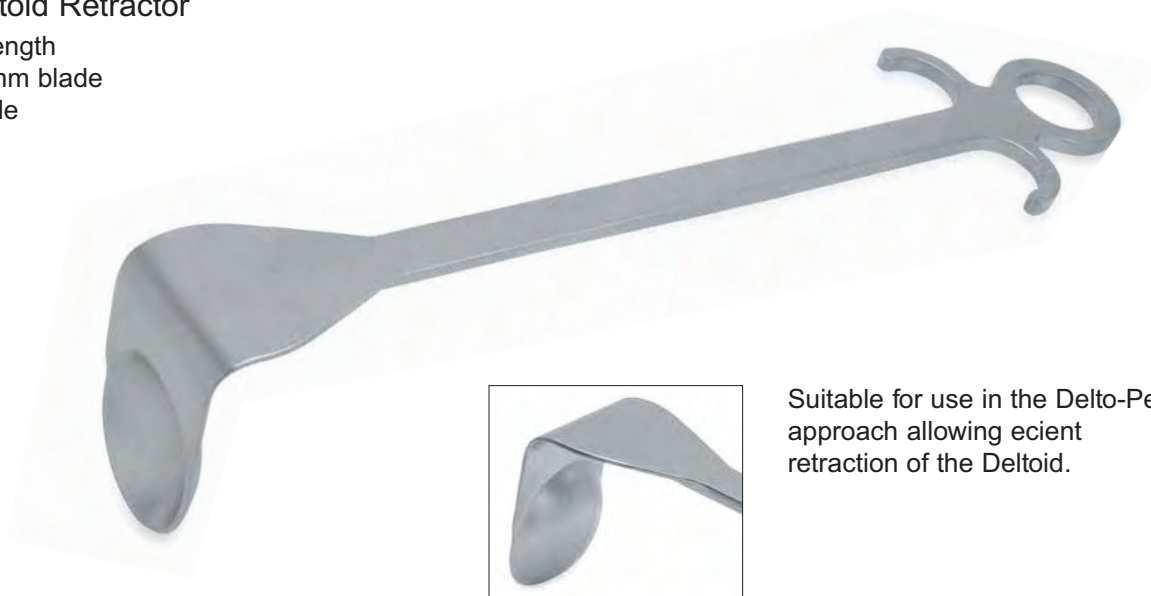

Suitable for use in the Delto-Pectoral approach allowing efficient retraction of the Deltoid.

Titanium Bladed Shoulder Retractor

Complete set with:

- 1x Frame
- 2x Blade holders
- 2 Sets of Titanium blades
- Sterilizing container

SF-05-50430



Frame with Articulating Joints

- Quick lock + unlock for blades
- Maximum spread 10cm

SF-05-50431



Blade Holder

SF-05-50432

Titanium Retractor Blades

- 30 angled
- Small blade size 22mm x 55mm
- Large blade size 22mm x 65mm



- 20mm width
- 24cm/9½ length

SF-05-50433



Richardson Retractor

- 28mm width
- 24cm/9½ length

SF-05-50434



Kolbel Tenectomy Ronguer

- 18cm/7" length
- Jaws 3mm bite
- Strong curved

SF-05-50435



Kolbel Bone Nibblers

- 18cm/7" length
- Jaws 5mm bite
- Light curved

SF-05-50436



Mallet

- 24cm/9½ length
- Tufnol handle
- 480 grams

SF-05-50437



Chisel with 4 Interchangeable Blades

- 20cm/8" length
- Tufnol handle
- Complete with blade sizes:
5mm, 10mm, 15mm, 25mm & key

SF-05-50438





Thank you for your interesting of
SURGIFACT® products

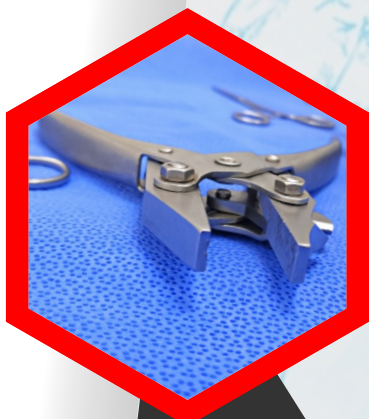

- ☎ +91-98155-11065, +91-98154-11065
- ✉ vaishanavsurgical@gmail.com
- 📷 www.instagram.com/vaishanavsurgical
- 🌐 www.surgifact.in

1382 / 1046, VSCO House, Raja Garden, Near Water Tank,
Basti Danishmandan, Jalandhar - 144002